



VAFMeter

MI 2230

Instruction manual

Version 1.2, Code no. 20 751 916

Distributor:

Manufacturer:

METREL d.d.
Ljubljanska cesta 77
1354 Horjul
Slovenia
web site: <http://www.metrel.si>
e-mail: metrel@metrel.si



Mark on your equipment certifies that this equipment meets the requirements of the EU (European Union) concerning safety and electromagnetic compatibility regulations

© 2011 METREL

The trade name Metrel, is trademark registered or pending in Europe and other countries.

No part of this publication may be reproduced or utilized in any form or by any means without permission in writing from METREL.

Table of contents

1	Preface	5
2	Safety and operational considerations.....	6
2.1	Warnings and notes	6
2.2	Battery and charging	8
2.2.1	<i>New battery cells or cells unused for a longer period</i>	<i>9</i>
2.3	Standards applied	10
3	Instrument description.....	11
3.1	Front panel	11
3.2	Connector panel	12
3.3	Back side.....	13
3.4	Display organization	15
3.4.1	<i>Key manipulation.....</i>	<i>15</i>
3.4.2	<i>Terminal voltage monitor.....</i>	<i>16</i>
3.4.3	<i>Battery indication.....</i>	<i>16</i>
3.4.4	<i>Message field.....</i>	<i>16</i>
3.4.5	<i>Result field</i>	<i>17</i>
3.4.6	<i>Help screens</i>	<i>17</i>
3.4.7	<i>Backlight and contrast adjustments</i>	<i>17</i>
3.5	Instrument set and accessories.....	18
3.5.1	<i>Standard set MI 2230.....</i>	<i>18</i>
3.5.2	<i>Optional accessories.....</i>	<i>18</i>
4	Instrument operation.....	19
4.1	Function selection	19
4.2	Settings	20
4.2.1	<i>Connection type</i>	<i>20</i>
4.2.2	<i>Clamp Settings.....</i>	<i>22</i>
4.2.3	<i>Memory</i>	<i>23</i>
4.2.4	<i>Language</i>	<i>23</i>
4.2.5	<i>Date and time.....</i>	<i>23</i>
4.2.6	<i>Initial settings</i>	<i>24</i>
5	Measurements	25
5.1	Voltage, current, power, THD, frequency and phase sequence	25
5.1.1	<i>UIF.....</i>	<i>25</i>
5.1.2	<i>PQS.....</i>	<i>28</i>
5.1.3	<i>Vector diagram.....</i>	<i>30</i>
5.1.4	<i>THD.....</i>	<i>31</i>
5.2	Resistance of connections.....	33
5.2.1	<i>R LOWΩ, 200 mA resistance measurement.....</i>	<i>34</i>
5.2.2	<i>Continuous resistance measurement with low current.....</i>	<i>35</i>
5.2.3	<i>Compensation of test leads resistance</i>	<i>36</i>
6	Data handling.....	38
6.1	Memory organization	38
6.2	Data structure.....	38
6.3	Storing test results.....	39

6.4	Recalling test results	39
6.5	Clearing stored data	40
6.5.1	Clearing complete memory content	40
6.5.2	Clearing measurement(s) in selected location	41
6.5.3	Clearing individual measurements	41
6.5.4	Renaming installation structure elements	42
6.6	Communication	42
7	Maintenance	44
7.1	Fuse replacement	44
7.2	Cleaning	44
7.3	Periodic calibration	44
7.4	Service	44
7.5	Upgrading the instrument	45
8	Technical specifications	46
8.1	General data	46
8.2	Voltage	46
8.3	Frequency*	46
8.4	Current (A 1398 - 10A current clamps)	47
8.5	Current (A 1395 – flex clamps)	47
8.6	Power (W, VA, Var)	47
8.7	Power factor - PF	48
8.8	Cos φ - DPF	48
8.9	Phase angle	48
8.10	Voltage and current THD	48
8.11	Resistance / Continuity	48
8.11.1	Resistance R LOW Ω	48
8.11.2	Resistance CONTINUITY	48

1 Preface

Congratulations on your purchase of the VAFMeter (Volt-Ampere-Phase-Meter) instrument and its accessories from METREL. The instrument was designed on a basis of rich experience, acquired through many years of dealing with electric installation test equipment.

The VAFMeter instrument is professional, multifunctional, hand-held test instrument intended to perform measurements required in order for a total inspection of electrical installations and devices in buildings and industry. The following measurements and tests can be performed:

- Voltages
- Currents
- Frequency
- Active, reactive and apparent powers
- Phase angles, $\cos \varphi$ and power factors
- Resistance/Continuity tests

The graphics display with backlight offers easy reading of results, indications, measurement parameters and messages. The operation of the instrument is designed to be as simple and clear as possible and no special training (except for the reading this instruction manual) is required in order to begin using the instrument.

In order for operator to be familiar enough with performing measurements in general and their typical applications it is advisable to read Metrel handbook "*Modern Power Quality Measurement Techniques*"

The instrument is equipped with the entire necessary accessory for comfortable testing.

2 Safety and operational considerations

2.1 Warnings and notes

In order to maintain the highest level of operator safety while carrying out various tests and measurements, Metrel recommends keeping your VAFMeter instrument in good condition and undamaged. When using the instrument, consider the following general warnings:

 **General warnings related to safety:**

- ❑ The  symbol on the instrument means »Read the Instruction manual with special care for safe operation«. The symbol requires an action!
- ❑ If the test equipment is used in a manner not specified in this user manual, the protection provided by the equipment could be impaired!
- ❑ Read this user manual carefully, otherwise the use of the instrument may be dangerous for the operator, the instrument or for the equipment under test!
- ❑ Do not use the instrument or any of the accessories if any damage is noticed!
- ❑ Consider all generally known precautions in order to avoid risk of electric shock while dealing with hazardous voltages!
- ❑ If a fuse blows in the instrument, follow the instructions in this manual in order to replace it!
- ❑ Do not use the instrument in AC supply systems with voltages higher than 600 VAC!
- ❑ Service, repairs or adjustment of instruments and accessories is only allowed to be carried out by competent authorized personnel!
- ❑ Use only standard or optional test accessories supplied by your distributor!
- ❑ The instrument comes supplied with rechargeable Ni-MH battery cells. The cells should only be replaced with the same type as defined on the battery compartment label or as described in this manual. Do not use standard alkaline battery cells while the power supply adapter is connected, otherwise they may explode!
- ❑ Hazardous voltages exist inside the instrument. Disconnect all test leads, remove the power supply cable and switch off the instrument before opening back cover!

- ❑ **All normal safety precautions must be taken in order to avoid risk of electric shock while working on electrical installations!**

 **Warnings related to measurement functions:**

Voltage, current, power, THD metering

- ❑ The user can browse through all sub-functions while the measurements are running. Pressing the TEST key starts/stops all sub-functions!
- ❑ Before starting any measurement the current Clamp settings and Connection type in Settings menu should be checked. Select appropriate current clamp model and measuring range that are best fitted to the expected current values.
- ❑ Consider polarity of current clamp (arrow on test clamp should be oriented toward connected load), otherwise result will be negative!

Continuity functions

- ❑ Continuity measurements should only be performed on de-energized objects!
- ❑ Parallel impedances or transient currents may influence test results.

2.2 Battery and charging

The instrument uses six AA size alkaline or rechargeable Ni-MH battery cells. Nominal operating time is declared for cells with nominal capacity of 2100 mAh.

Battery condition is always displayed in the lower right display part.

In case the battery is too weak the instrument indicates this as shown on Figure 2.1. This indication appears for a few seconds and then the instrument turns itself off.

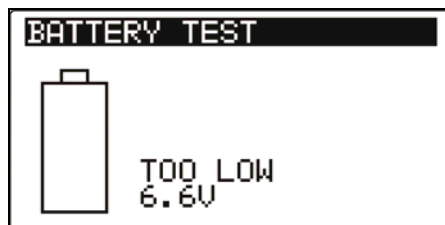

Figure 2.1: Discharged battery indication

The battery is charged whenever the power supply adapter is connected to the instrument. The power supply socket polarity is shown on Figure 2.2. Internal circuit controls charging and assures maximum battery lifetime.



Figure 2.2: Power supply socket polarity

The instrument automatically recognizes the connected power supply adapter and begins charging the batteries if they are present.

Symbols:

	Indication of connected power supply and battery charging (if batteries are present)
--	--



Figure 2.3: Charging indication

- ❑ When connected to an installation, the instruments battery compartment can contain hazardous voltage inside! When replacing battery cells or before opening the battery/fuse compartment cover, disconnect any measuring accessory connected to the instrument and turn off the instrument,
- ❑ Ensure that the battery cells are inserted correctly otherwise the instrument will not operate and the batteries could be discharged.
- ❑ If the instrument is not to be used for a long period of time, remove all batteries from the battery compartment.
- ❑ Alkaline or rechargeable Ni-MH batteries (size AA) can be used. Metrel recommends only using rechargeable batteries with a capacity of 2100mAh or above.
- ❑ Do not recharge alkaline battery cells!
- ❑ Use only power supply adapter delivered from the manufacturer or distributor of the test equipment to avoid possible fire or electric shock!

2.2.1 New battery cells or cells unused for a longer period

Unpredictable chemical processes can occur during the charging of new battery cells or cells that have been left unused for a longer period (more than 3 months). Ni-MH cells can be subjected to these chemical effects (sometimes called the memory effect). As a result the instrument operation time can be significantly reduced during the initial charging/discharging cycles of the batteries.

In this situation, Metrel recommend the following procedure to improve the battery lifetime:

Procedure	Notes
➤ Completely charge the battery.	At least 14h with in-built charger.
➤ Completely discharge the battery.	This can be performed by using the instrument normally until the instrument is fully discharged.
➤ Repeat the charge / discharge cycle at least 2-4 times.	Four cycles are recommended in order to restore the batteries to their normal capacity.

Notes:

- ❑ The charger in the instrument is a pack cell charger. This means that the battery cells are connected in series during the charging. The battery cells have to be equivalent (same charge condition, same type and age).
- ❑ One different battery cell can cause an improper charging and incorrect discharging during normal usage of the entire battery pack (it results in heating of the battery pack, significantly decreased operation time, reversed polarity of defective cell,...).
- ❑ If no improvement is achieved after several charge / discharge cycles, then each battery cell should be checked (by comparing battery voltages, testing them in a cell charger, etc). It is very likely that only some of the battery cells are deteriorated.
- ❑ The effects described above should not be confused with the normal decrease of battery capacity over time. Battery also loses some capacity when it is repeatedly charged / discharged. Actual decreasing of capacity, versus number of charging cycles, depends on battery type. This information is provided in the technical specification from battery manufacturer.

2.3 Standards applied

The VAFMeter instrument is manufactured and tested in accordance with the following regulations:

Electromagnetic compatibility (EMC)

EN 61326	Electrical equipment for measurement, control and laboratory use – EMC requirements Class B (Hand-held equipment used in controlled EM environments)
----------	--

Safety (LVD)

EN 61010-1	Safety requirements for electrical equipment for measurement, control and laboratory use – Part 1: General requirements
EN 61010-2-030	Safety requirements for electrical equipment for measurement, control and laboratory use – Part 2-030: Particular requirements for testing and measuring circuits
EN 61010-031	Safety requirements for hand-held probe assemblies for electrical measurement and test
EN 61010-2-032	Safety requirements for electrical equipment for measurement, control, and laboratory use - Part 2-032: Particular requirements for hand-held and hand-manipulated current sensors for electrical test and measurement

Functionality

EN 61000-4-30	Testing and measurement techniques – Power quality measurement methods
EN 61557-12	Equipment for testing, measuring or monitoring of protective measures – Part 12: Performance measuring and monitoring devices (PMD)
EN 61000-4-7	General guide on harmonics and interharmonics measurements and instrumentation

Note about EN and IEC standards:

- Text of this manual contains references to European standards. All standards of EN 6XXXX (e.g. EN 61010) series are equivalent to IEC standards with the same number (e.g. IEC 61010) and differ only in amended parts required by European harmonization procedure.

3 Instrument description

3.1 Front panel



Figure 3.1: Front panel

Legend:

1	LCD	128 x 64 dots matrix display with backlight.
2	UP/DOWN	Modifies selected parameter.
3	TEST	Starts measurements.
4	ESC	Goes one level back.
5	TAB	Selects the parameters in selected function.
6	Backlight, Contrast	Changes backlight level and contrast.
7	Red/Green LED	Pass / fail functionality in Continuity / R Low Ω measurements
8	ON / OFF	Switches the instrument power on or off. <i>The instrument automatically turns off 15 minutes after the last key was pressed.</i>
9	HELP / CAL	Accesses help menus.
10	Function selector	Calibrates test leads in Continuity / R Low Ω functions.
11	MEM	Store / recall / clear tests in memory of instrument.

3.2 Connector panel

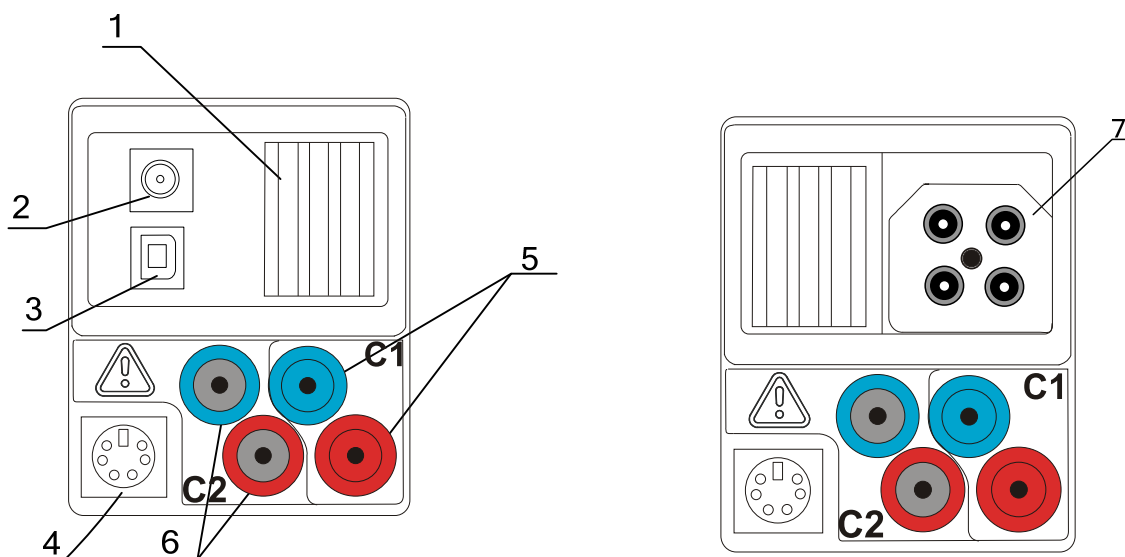

Figure 3.2: Connector panel

Legend:

1	Protection cover	
2	Charger socket	
3	USB connector	Communication with PC. USB (1.1) port.
4	PS/2 connector	Communication with PC serial port and connection to optional measuring adapters.
5	C1	Current clamp measuring input I_1
6	C2	Current clamp measuring input I_2
7	Test connector	Measuring inputs / outputs

Warnings!

- ❑ **Maximum allowed voltage between any test terminal and ground is 600 V!**
- ❑ **Maximum allowed voltage between Test connector terminals is 600 V!**
- ❑ **Maximum allowed voltage between test terminals C1, C2 is 3 V!**
- ❑ **Maximum short-term voltage of external power supply adapter is 14 V!**

3.3 Back side

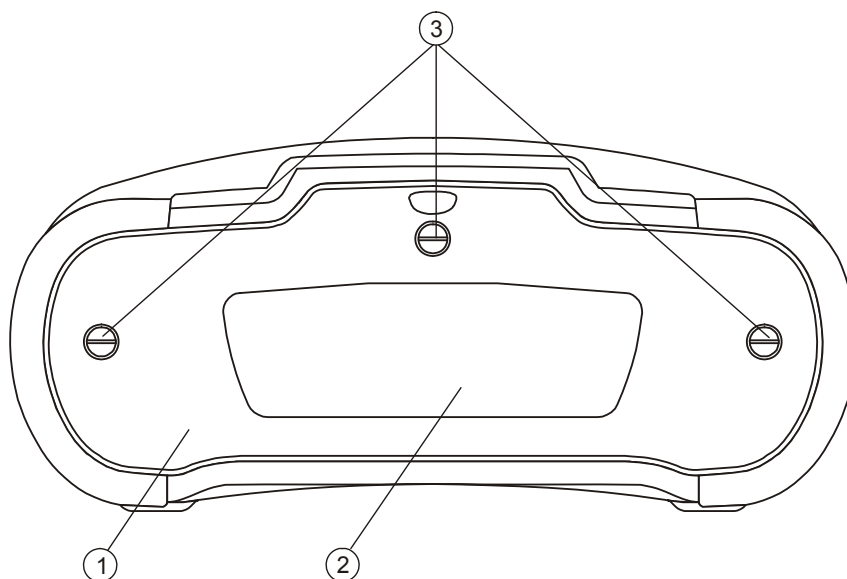

Figure 3.3: Back panel

Legend:

- | | |
|---|--|
| 1 | Battery / fuse compartment cover |
| 2 | Back panel information label |
| 3 | Fixing screws for battery / fuse compartment cover |

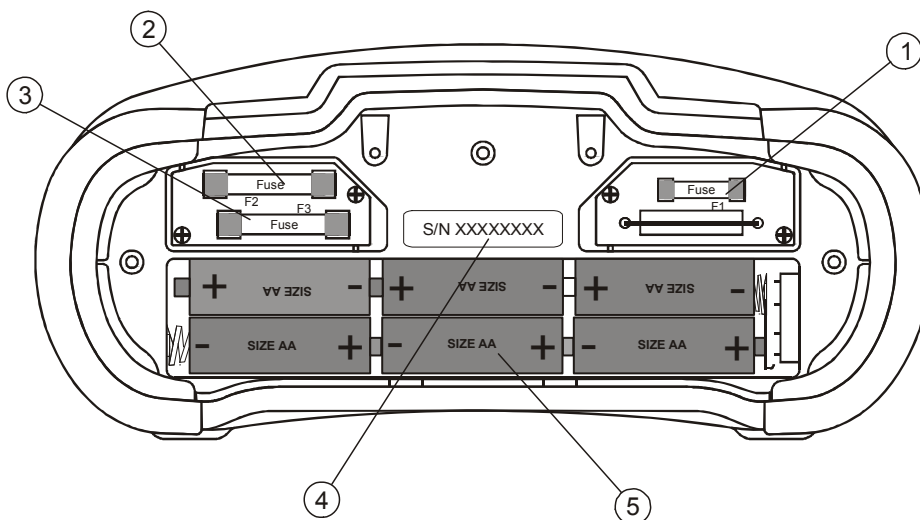

Figure 3.4: Battery and fuse compartment

Legend:

- | | | |
|---|---------------------|---------------------------------------|
| 1 | Fuse F1 | M 315 mA / 250 V |
| 2 | Fuse F2 | F 4 A / 500 V |
| 3 | Fuse F3 | F 4 A / 500 V |
| 4 | Serial number label | |
| 5 | Battery cells | Size AA, alkaline / rechargeable NiMH |

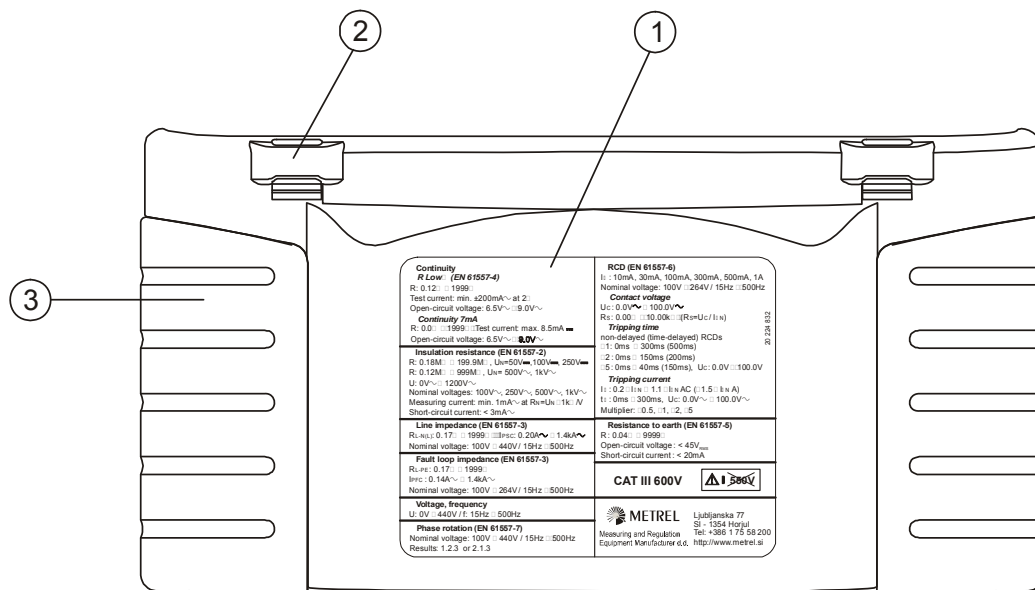

Figure 3.5: Bottom

Legend:

- 1 Bottom information label
- 2 Neck belt openings
- 3 Handling side covers

3.4 Display organization

3.4.1 Key manipulation

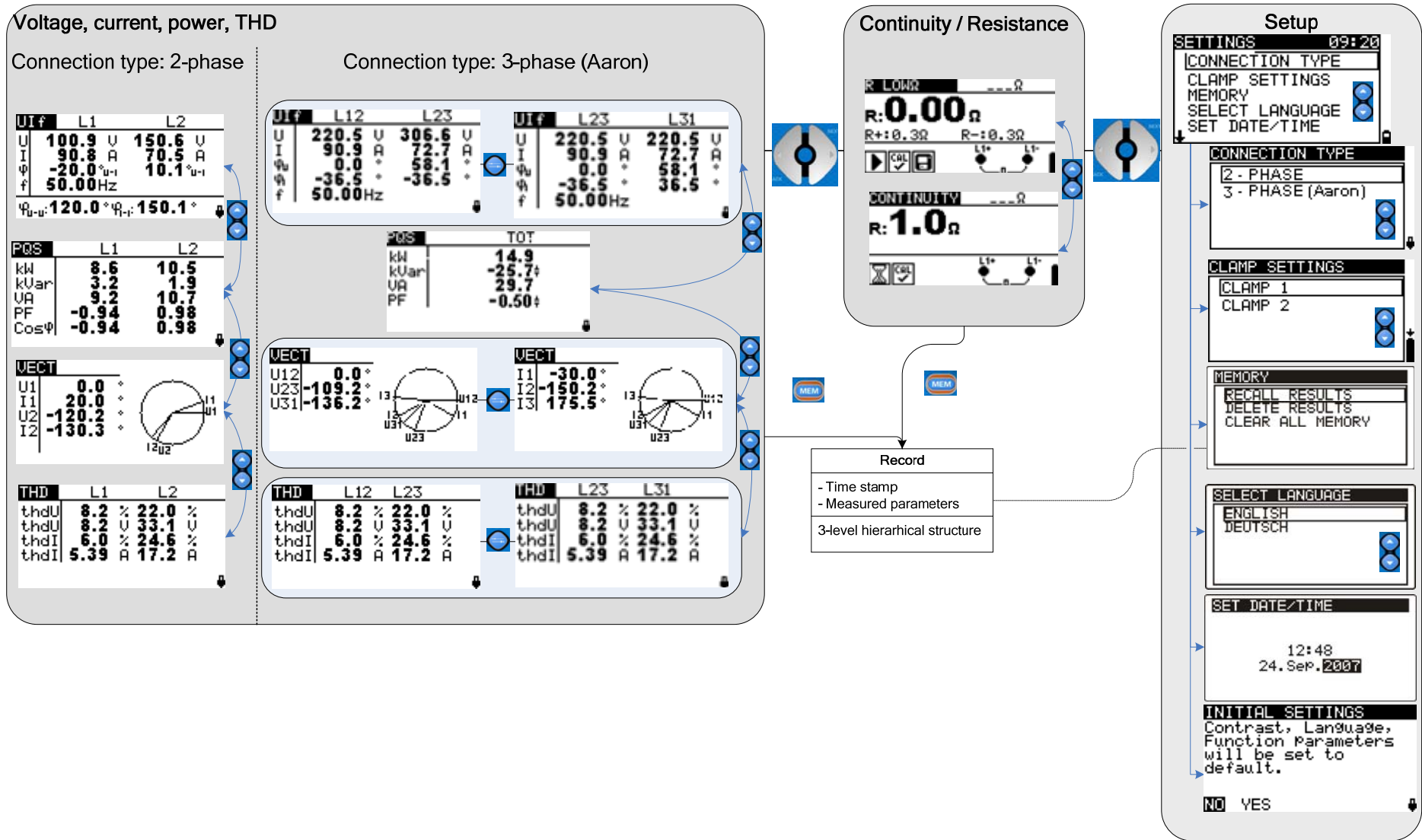

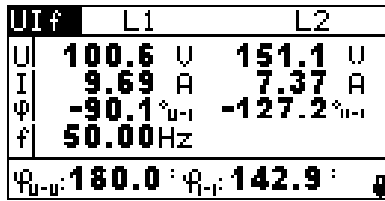

Figure 3.6: Typical function display

UI f	Function name
U 100.6 V 151.1 V I 9.69 A 7.37 A φ -90.1 % _{U-I} -127.2 % _{U-I} f 50.00 Hz P _{U-U} : 180.0 ; P _{I-I} : 142.9 ;	Result field
L1 L2	Label field
	Battery and charger indication

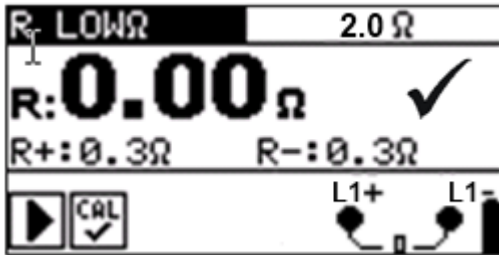

Figure 3.7: Typical function display

R LOW Ω	Function name
R: 0.00 Ω R+: 0.3 Ω R-: 0.3 Ω	Result field
	Message field
L1+ L1-	Terminal voltage monitor
	Battery and charger indication

3.4.2 Terminal voltage monitor

The terminal voltage monitor displays on-line the voltages on the test terminals and information about active test terminals.



Online voltages are displayed together with test terminal indication. L2+ and L1- test terminals are used for selected measurement.

3.4.3 Battery indication

The indication indicates the charge condition of battery and connection of external charger.



Battery capacity indication.



Low battery.

Battery is too weak to guarantee correct result. Replace or recharge the battery cells.

3.4.4 Message field

In the message field warnings and messages are displayed.







Measurement is running.





Conditions on the input terminals allow starting the measurement; consider other displayed warnings and messages.



Conditions on the input terminals do not allow starting the measurement; consider displayed warnings and messages.

	Result(s) can be stored.
	Test leads resistance in R LowΩ and Continuity measurement is not compensated.
	Test leads resistance in R LowΩ and Continuity measurement is compensated.
	Fuse F1 broken.

3.4.5 Result field

	Measurement result is inside pre-set limits (PASS).
	Measurement result is out of pre-set limits (FAIL).
	Measurement is aborted. Consider displayed warnings and messages.

3.4.6 Help screens

HELP	Opens help screen.
-------------	--------------------

The Help menu contains schematic diagrams for illustrating how to properly connect the instrument to electric installation. After selecting the measurement you want to perform, press the HELP key in order to view the associated Help menu. Help menus is not available in LowΩ / Continuity functions, as HELP key is used for calibration.

Keys in help menu:

UP / DOWN	Selects next / previous help screen.
TAB	Scrolls through help screens.
ESC / Function selector	Exits help menu.

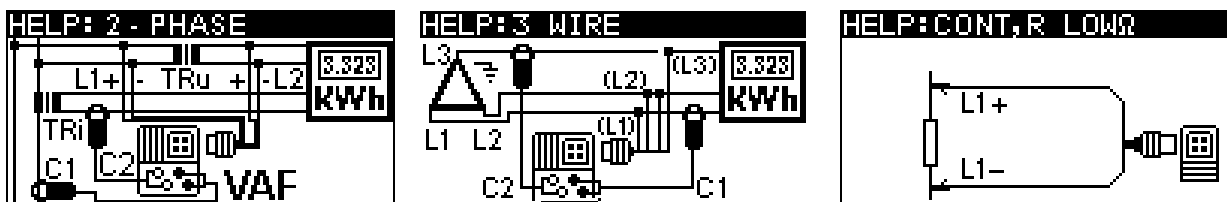

Figure 3.8: Examples of help screens

3.4.7 Backlight and contrast adjustments

With the **BACKLIGHT** key backlight and contrast can be adjusted.

Click	Toggles backlight intensity level.
Keep pressed for 1 s	Locks high intensity backlight level until power is turned off or the key is pressed again.
Keep pressed for 2 s	Bargraph for LCD contrast adjustment is displayed.



Figure 3.9: Contrast adjustment menu

Keys for contrast adjustment:

DOWN	Reduces contrast.
UP	Increases contrast.
TEST	Accepts new contrast.

3.5 Instrument set and accessories

3.5.1 Standard set MI 2230

- Instrument
- Instruction manual
- Calibration Certificate
- Test lead 4 x 1.5 m
- Test probe, 4 pcs
- Two A 1398 - 10 A current clamps
- Crocodile clip, 4 pcs
- Set of NiMH battery cells
- Power supply adapter
- CD with instruction manual, EuroLink Software and “*Modern Power Quality Measurement Techniques*” handbook.
- Set of carrying straps

3.5.2 Optional accessories

See the attached sheet for a list of optional accessories that are available on request from your distributor.

4 Instrument operation

4.1 Function selection

For selecting test function the **FUNCTION SELECTOR** shall be used.

Keys:

FUNCTION SELECTOR	Select test / measurement function: <ul style="list-style-type: none"> <input type="checkbox"/> <VAF> Voltage and frequency, phase sequence, power, THD. <input type="checkbox"/> <R LOWΩ> Resistance of earth connections and bondings. <input type="checkbox"/> <SETTINGS> General instrument settings.
UP/DOWN	Selects sub-function in selected measurement function.
TAB	Selects the test parameter to be set or modified. Selects screen to be viewed (if results are split into more screens).
TEST	Runs selected test / measurement function.
MEM	Stores measured results / recalls stored results.
ESC	Returns back to higher levels.

Keys in **test parameter** field:

UP/DOWN	Changes the selected parameter.
TAB	Selects the next measuring parameter.
Function selector	Toggles between the main functions.
MEM	Stores measured results / recalls stored results.

General rule regarding enabling **parameters** for evaluation of measurement / test result:

Parameter	OFF	No limit values, indication: <u> </u> .
	ON	Value(s) – results will be marked as PASS or FAIL in accordance with selected limit.

See chapter 5 for more information about the operation of the instrument test functions.

4.2 Settings

Different instrument options can be set in the **SETTINGS** menu.

Options are:

- Setting the connection type,
- Setting the current clamps,
- Recalling and clearing stored results
- Selection of language,
- Setting the date and time,
- Setting the instrument to initial values,
- Show Instrument data.

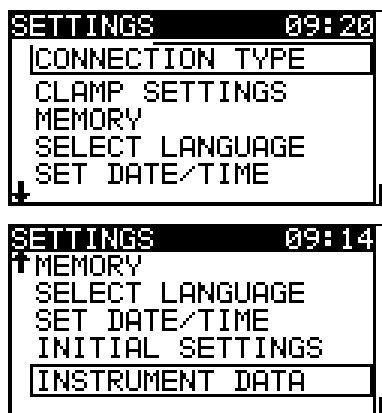

Figure 4.1: Options in Settings menu

Keys:

UP / DOWN	Selects appropriate option.
TEST	Enters selected option.
Function selector	Exits back to main function menu.

4.2.1 Connection type

In Connection type menu, instrument wiring can be selected.

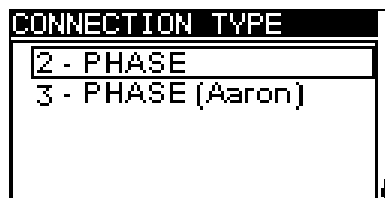

Figure 4.2: Configuration of connection type

Parameters to be set:

2 Phase	Connection in single phase (L1, I1 only) or two phase (four-poles) systems
----------------	--

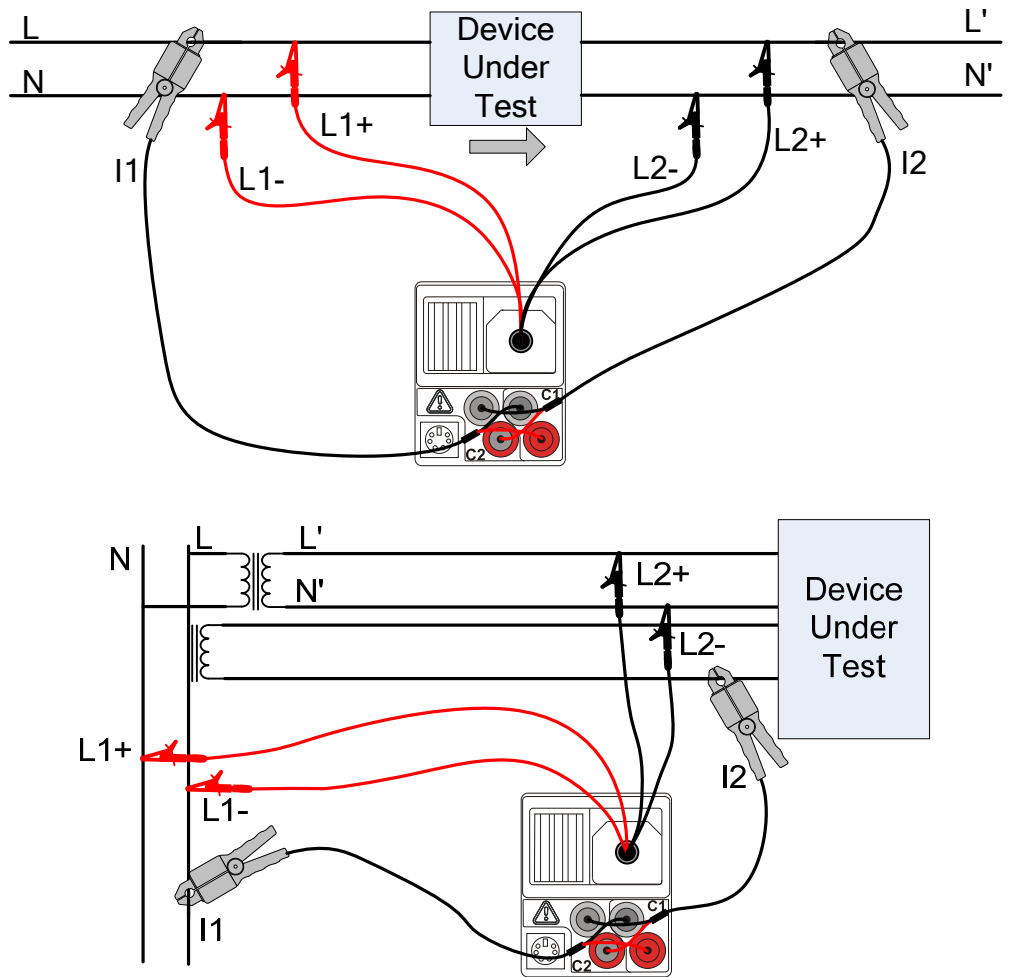

Figure 4.3: 2 phase connection

3 Phase (Aaron)

Connection in three-phase, three wire system

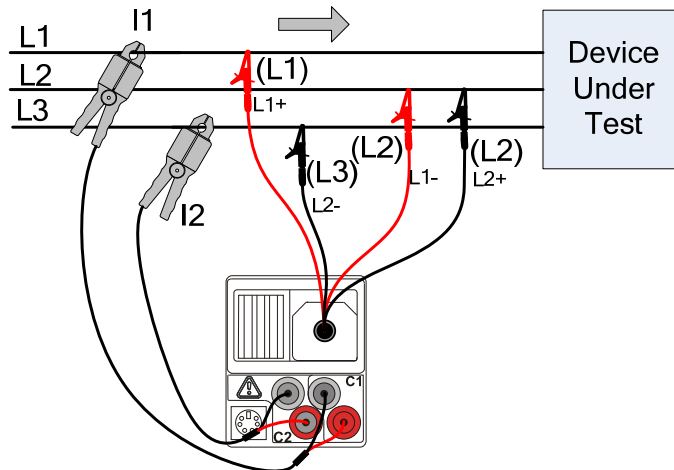

Figure 4.4: 3 phase (Aaron) connection

Keys:

UP / DOWN	Selects appropriate option.
TEST	Confirms selection.
ESC / Function selector	Exits back without confirmation.

4.2.2 Clamp Settings

In Clamp settings menu the C1 and C2 measuring inputs can be configured.

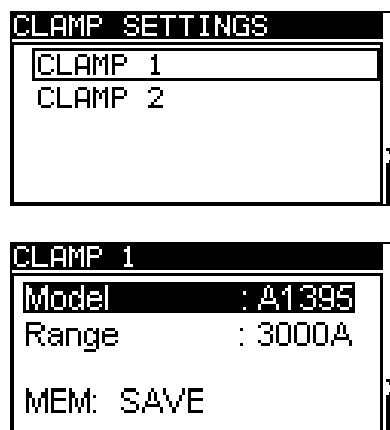

Figure 4.5: Configuration of current clamp measuring inputs

Selection of clamp input

Keys:

UP / DOWN	Selects current clamp measuring input.
TEST	Enters clamp menu.
ESC / Function selector	Exits back.

Parameters to be set in Clamp menu:

Model	Model of current clamp.
Range	Measuring range of current clamp.

Selection of parameters

Keys:

UP / DOWN	Selects appropriate option.
TEST	Enables changing data of selected parameter.
MEM	Confirms selection.
ESC / Function selector	Exits back.

Changing data of selected parameter

Keys:

UP / DOWN	Sets parameter.
TEST	Confirms set data.
MEM	Confirms selection.
ESC / Function selector	Exits back.

4.2.3 Memory

In this menu the stored data can be recalled and deleted. See chapter 6 *Data handling* for more information.

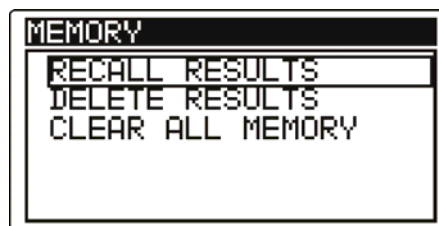

Figure 4.6: Memory menu

Keys:

UP / DOWN	Selects option.
TEST	Enters selected option.
ESC / Function selector	Exits back.

4.2.4 Language

In this menu the language can be set.



Figure 4.7: Language selection

Keys:

UP / DOWN	Selects language.
TEST	Confirms selected language and exits to settings menu.
ESC / Function selector	Exits back without confirmation.

4.2.5 Date and time

In this menu date and time can be set.



Figure 4.8: Setting date and time

Keys:

TAB	Selects the field to be changed.
UP / DOWN	Modifies selected field.
TEST	Confirms new setup and exits.
ESC / Function selector	Exits back without confirmation.

Warning:

- If the batteries are removed for more than 1 minute the set time and date will be lost.

4.2.6 Initial settings

In this menu the instrument settings and measurement parameters and limits can be set to initial (factory) values.

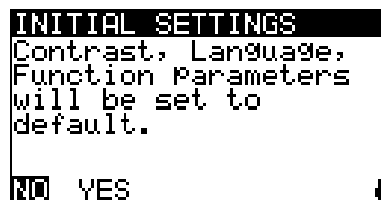

Figure 4.9: Initial settings dialogue

Keys:

UP / DOWN	Selects YES or NO.
TEST	Restores default settings (if YES selected).
	Exits back without changes (if NO selected).
ESC / Function selector	Exits back without changes.

Warning:

- Customized settings will be lost when this option is used!
- If the batteries are removed for more than 1 minute the custom made settings will also be lost.

The default setup is listed below:

Instrument setting	Default value
Contrast	As defined and stored by adjustment procedure
Language	English
Clamp settings:	Model: A1398 Range: 10 A
Connection type:	2 phase
Function Sub-function	Parameters / limit value
Low Ohm Resistance	
R LOW Ω	No limit
CONTINUITY	No limit

Note:

- Initial settings (reset of the instrument) can be recalled also if the TAB key is pressed while the instrument is switched on.

5 Measurements

5.1 Voltage, current, power, THD, frequency and phase sequence

5.1.1 UIF

UIF screen shows RMS (root means square) voltages, currents and phase angles which are measured by the instrument. Instrument show relevant measurements for chosen connection type: 2-phase or 3-phase (Aaron) system.

UIF measurement procedure

- ❑ Select appropriate connection type (see chapter: 4.2.1 Connection type).
- ❑ Configure clamp settings if needed (see chapter: 4.2.2 Clamp Settings).
- ❑ Select the **UIF** sub-function using function selector and UP/DOWN keys.
- ❑ Measurements will start automatically.
- ❑ **Connect** test lead and current clamps to the instrument.
- ❑ **Connect** test lead to the item to be measured (see Figure 4.3 and Figure 4.4).
- ❑ **Embrace** wires where current should be measured.
- ❑ Press the **TEST** key again to stop the measurement. All sub-functions will stop.
- ❑ **Store** voltage measurement result by pressing the **MEM** key (optional).
- ❑ Press the **TEST** key to start again the measurement. All sub-functions will start.

UIF	L1	L2
U	100.9 U	150.6 U
I	90.8 A	70.5 A
Φ	-20.0° _{U-I}	10.1° _{U-I}
f	50.00Hz	
Φ_{U-U}	120.0°	Φ_{I-I} : 150.1°

Figure 5.1: Uif measurement in 2-phase system

Displayed results for 2-phase system:

- U₁ RMS Voltage between L1+ and L1- conductors,
- U₂ RMS Voltage between L2+ and L2- conductors,
- I₁ Current measured on I₁ current clamps.
- I₂ Current measured on I₂ current clamps.
- Φ_{U1-I1} Phase angle between voltage U₁ and current I₁ fundamentals
- Φ_{U2-I2} Phase angle between voltage U₂ and current I₂ fundamentals
- f Frequency of voltage U₁. If U₁ is to low, frequency of I₁ is shown.
- Φ_{U-U} Phase angle between voltages U₁ and U₂
- Φ_{I-I} Phase angle between currents I₁ and I₂

UIf	L12	L23
U	220.5 U	306.6 U
I	90.9 A	72.7 A
Φ_U	0.0°	58.1°
Φ	-36.5°	-36.5°
f	50.00Hz	

UIf	L23	L31
U	220.5 U	220.5 U
I	90.9 A	72.7 A
Φ_U	0.0°	58.1°
Φ	-36.5°	36.5°
f	50.00Hz	

Figure 5.2: Uif measurement in 3-phase (Aaron) system

Displayed results for three-phase (Aaron) system:
 U₁₂..... Measured voltage between phases L1 and L2,
 U₂₃..... Measured voltage between phases L2 and L3,
 U₃₁..... Calculated voltage between phases L3 and L1,
 I₁₂ Measured current I₁ on phase L1.
 I₂₃ Current calculated I₂ on phase L2.
 I₃₁ Measured current I₃ on phase L3.
 φ_{U12} Phase angle of voltage U₁₂
 φ_{U23} Phase angle of voltage U₂₃
 φ_{U31} Phase angle of voltage U₃₁
 φ_{I12} Phase angle of current I₁₂ on phase L1.
 φ_{I23} Phase angle of current I₂₃ on phase L2.
 φ_{I31} Phase angle of current I₃₁ on phase L3.
 f Frequency of voltage U₁₂. If U₁₂ is too low, freq. of current on phase L1 is shown.

Keys:

Function selector	Toggles between the main functions.
UP/DOWN	Toggles between sub-functions.
TAB	Toggles between multiple result screens.
TEST	Starts / stops the measurement.
MEM	Stores measured results / recalls stored results.

All voltage and current measurements represent RMS values of 512 samples of the voltage magnitude over a 10-cycle time interval.

Voltage values are measured according to the following equation:

$$\text{Phase voltage: } U_p = \sqrt{\frac{1}{1024} \sum_{j=1}^{1024} u_{p_j}^2} \quad [V], p: 1,2 \quad (1)$$

$$\text{Phase to phase voltage: } U_{pg} = \sqrt{\frac{1}{1024} \sum_{j=1}^{1024} (u_{p_j} - u_{g_j})^2} \quad [V], pg: 12,23,31 \quad (2)$$

The instrument has 7 voltage ranges internally, which are switched automatically, regarding the measured voltage.

Current values are measured according to the following equation:

$$\text{Phase current: } I_p = \sqrt{\frac{1}{1024} \sum_{j=1}^{1024} I_{p_j}^2} \quad [A], p: 1,2 \quad (3)$$

The instrument has 4 current ranges internally, which are switched automatically, regarding the measured current.

Measurement of phase angles is performed on fundamental components of current and voltage. Synchronization channel (voltage U₁, U₁₂ or current I₁) is drawn on positive x-axis, and has angle zero. In 2-phase connection, phase angles are measured between

voltage and current, voltages U_1 and U_2 , and currents I_1 and I_2 , according to the figure and formulas below.

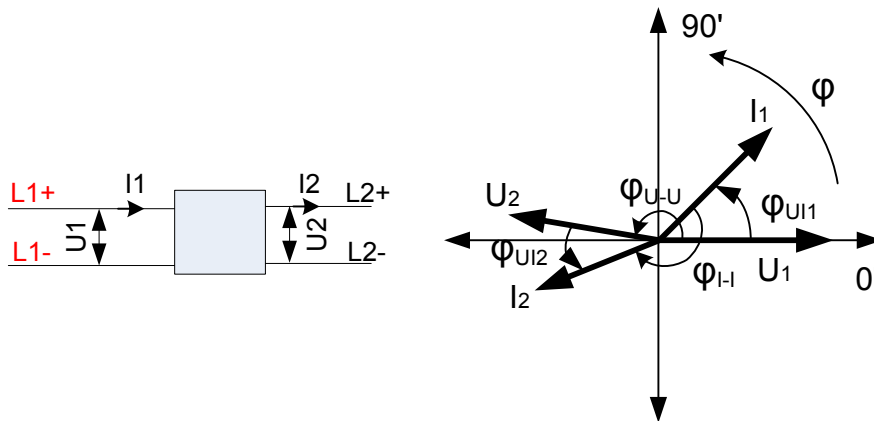

Voltage to current phase angle: $\varphi_{U-I_p} = \varphi(U_p) - \varphi(I_p) \text{ [}^\circ\text{]}, p: 1,2$ (4)

Voltage to voltage phase angle: $\varphi_{U-U} = \varphi(U_1) - \varphi(U_2) \text{ [}^\circ\text{]}$ (5)

Current to current phase angle: $\varphi_{I-I} = \varphi(I_1) - \varphi(I_2) \text{ [}^\circ\text{]}$ (6)

In 3-phase (Aaron) connection, angles shown on instrument represents voltage and current angles of voltages and current vectors in vector diagram. Synchronization channel (voltage U_{12} or current I_1) is drawn on positive x-axis, and has angle zero. Figure below graphically represents phase angles values and its meanings.

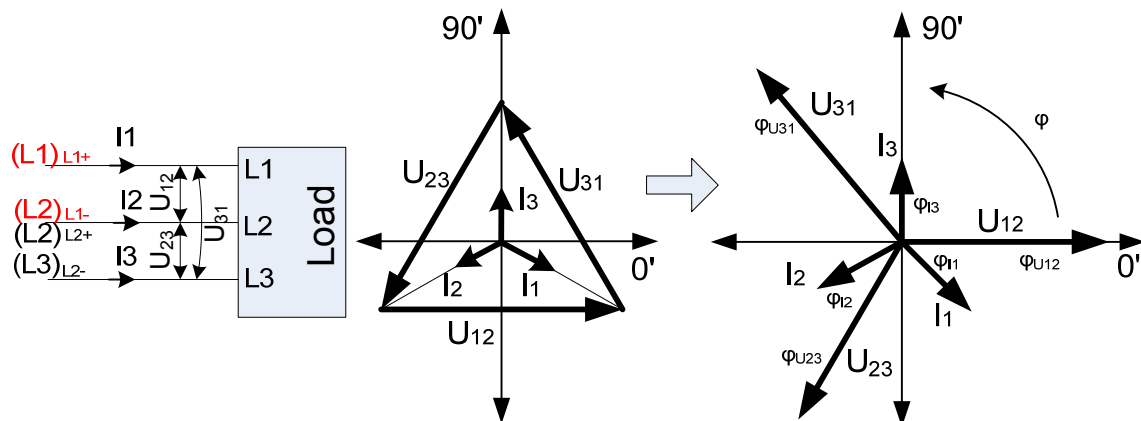

Voltage phase angle: $\varphi_{U_{pg}} = \varphi(U_{pg}) \text{ [}^\circ\text{]}, pg: 12, 23, 31$ (7)

Current phase angle: $\varphi_{I_p} = \varphi(I_p) \text{ [}^\circ\text{]}, p: 1, 2, 3$ (8)

Frequency reading is obtained from 10 cycles, as ratio of 10 cycles and the duration of the integer cycles.

$$\text{Frequency: } f = \frac{10}{\text{duration_of_10_cycles}} \text{ [Hz]} \quad (9)$$

5.1.2 PQS

In this sub-function standard 2-phase and 3-phase (Aaron) power measurements can be performed with the instrument.

PQS measurement procedure

- ❑ Select appropriate connection type (see chapter: 4.2.1 *Connection type*).
- ❑ Configure clamp settings if needed (see chapter: 4.2.2 *Clamp Settings*).
- ❑ Select **PQS** sub-function using function selector and UP/DOWN keys.
- ❑ Measurements will start automatically.
- ❑ **Connect** test lead and current clamps to the instrument.
- ❑ **Connect** test lead to the item to be measured (see *Figure 4.3* and *Figure 4.4*).
- ❑ **Embrace** wires where current should be measured.
- ❑ Press the **TEST** key to stop the measurement. All sub-functions will stop.
- ❑ **Store** the result by pressing the **MEM** key (optional).
- ❑ Press the **TEST** key again to start the measurement. All sub-functions will start.

	PQS	L1	L2
P	kW	8.6	10.5
Q	kVar	3.2	1.9
S	VA	9.2	10.7
	PF	-0.94	0.98
	DPF	-0.94	0.98

Figure 5.3: Power measurement in 2-phase system

Displayed results for 2-phase system:

- P₁ Active power on L1 channel
- P₂ Active power on L2 channel
- Q₁ Reactive power on L1 channel
- Q₂ Reactive power on L2 channel
- S₁ Apparent power on L1 channel
- S₂ Apparent power on L2 channel
- PF₁ Power factor on L1 channel
- PF₂ Power factor on L2 channel
- DPF₁ Displacement power factor (Cosφ₁) on L1 channel
- DPF₂ Displacement power factor (Cosφ₂) on L2 channel

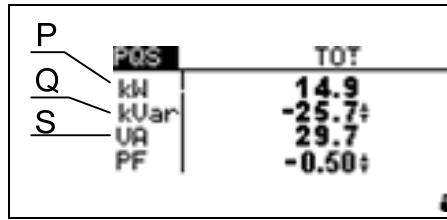

Figure 5.4: Power measurements in 3-phase (Aaron) system

Displayed results for 3-phase (Aaron) system:

- P_{tot} Total active power
- Q_{tot} Total reactive power
- S_{tot} Total apparent power
- PF_{tot} Total Power factor

Keys:

Function selector	Toggles between the main functions.
UP/DOWN	Toggles between sub-functions.
TEST	Starts / stops the measurement.
MEM	Stores measured results / recalls stored results.

All active power measurements represent RMS values of the 512 samples of instantaneous power over a 10-cycle time interval.

Phase active power:

$$P_p = \frac{1}{1024} \sum_{j=1}^{1024} p_{pj} = \frac{1}{1024} \sum_{j=1}^{1024} U_{pj} * I_{pj} \quad [\text{W}], p: 1,2 \quad (10)$$

Apparent and reactive power, power factor and displacement power factor (Cos φ) are calculated according to the following equations:

Phase apparent power: $S_p = U_p * I_p \quad [\text{VA}], p: 1,2 \quad (11)$

Phase reactive power: $Q_p = \text{Sign}(Q_p) * \sqrt{S_p^2 - P_p^2} \quad [\text{VAr}], p: 1,2 \quad (12)$

Sign of reactive power: $\text{Sign}(Q_p) = \begin{cases} +1, \varphi_p \in [0^\circ \div 180^\circ] \\ -1, \varphi_p \in [0^\circ \div -180^\circ] \end{cases} \quad p: 1,2 \quad (13)$

Phase power factor: $PF_p = \frac{P_p}{S_p}, p: 1,2 \quad (14)$

DPF (Cos φ): $\text{Cos } \varphi_p = \text{Cos}(\varphi_{u_p} - \varphi_{i_p}), p: 1,2 \quad (15)$

Total active, reactive and apparent power and total power factor are calculated according to the following equations:

Total active power: $P_t = P_1 + P_2 \quad [\text{W}], \quad (16)$

$$\text{Total reactive power (vector): } Q_t = Q_1 + Q_2 \text{ [VAr]}, \quad (17)$$

$$\text{Total apparent power (vector): } S_t = \sqrt{(P_t^2 + Q_t^2)} \text{ [VA]}, \quad (18)$$

$$\text{Total power factor (vector): } PF_{tot} = \frac{P_t}{S_t}. \quad (19)$$

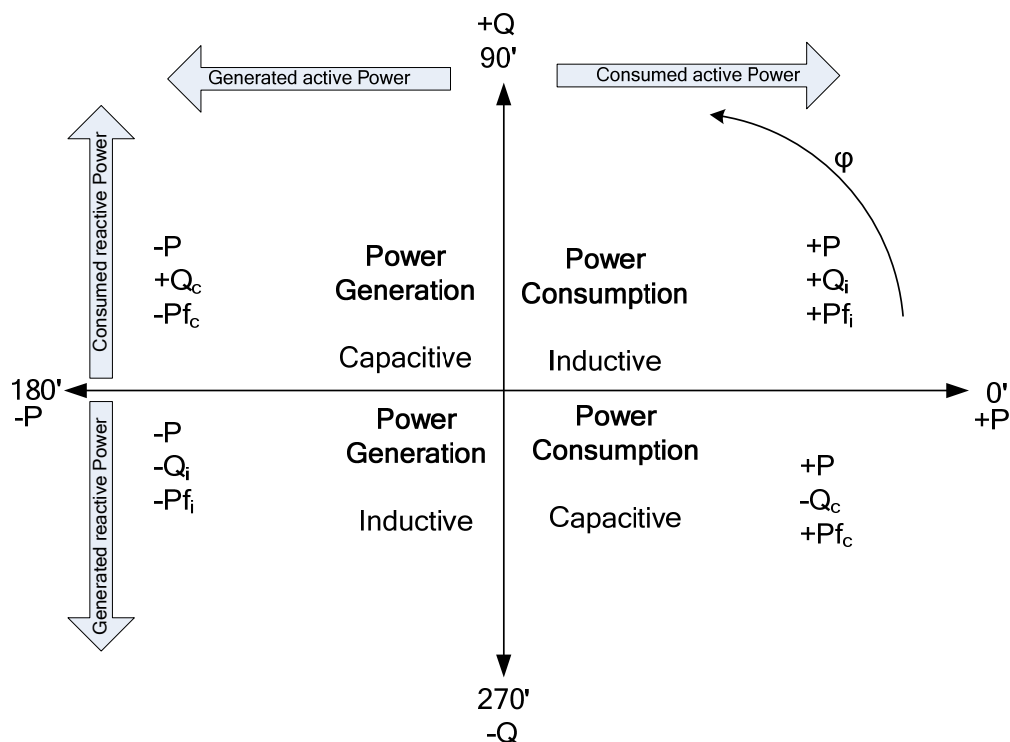

Figure 5.5: Vector representation of 4-quadrant power calculus

5.1.3 Vector diagram

Vector diagram shows angles of voltages and current vectors in degrees. Instrument shows relevant measurements for chosen connection type: 2-phase or 3-phase (Aaron) system.

Vector diagram measurement procedure

- ❑ Select appropriate connection type (see chapter: 4.2.1 Connection type).
- ❑ Configure clamp settings if needed (see chapter: 4.2.2 Clamp Settings).
- ❑ Select the **VECT** sub-function using function selector and UP/DOWN keys.
- ❑ Measurements will start automatically.
- ❑ **Connect** test lead and current clamps to the instrument.
- ❑ **Connect** test lead to the item to be measured (see Figure 4.3 and Figure 4.4).
- ❑ **Embrace** wires where current should be measured.
- ❑ Press the **TEST** key to stop the measurement. All sub-functions will stop.
- ❑ **Store** the result by pressing the **MEM** key (optional).
- ❑ Press the **TEST** key again to start the measurement. All sub-functions will start.

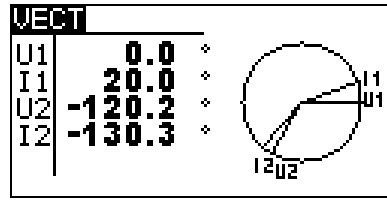

Figure 5.6: Vector diagram in 2-phase system

Displayed results for 2-phase system:

- U₁ Phase angle of voltage vector U₁
- U₂ Phase angle of voltage vector U₂
- I₁ Phase angle of current vector I₁
- I₂ Phase angle of current vector I₂

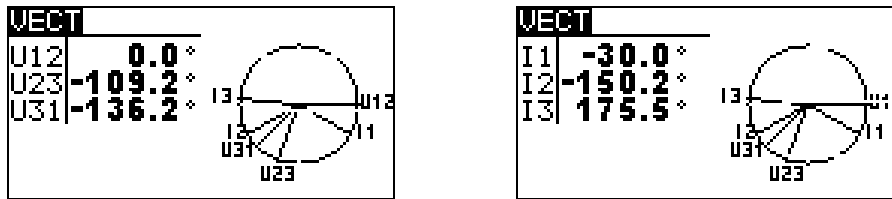

Figure 5.7: Vector diagram in 3-phase (Aaron) system

Displayed results for 3-phase (Aaron) system:

- U₁₂ Phase angle of voltage vector U₁₂
- U₂₃ Phase angle of voltage vector U₂₃
- U₃₁ Phase angle of voltage vector U₃₁
- I₁ Phase angle of current vector I₁
- I₂ Phase angle of current vector I₂
- I₃ Phase angle of current vector I₃

Keys:

Function selector	Toggles between the main functions.
UP/DOWN	Toggles between sub-functions.
TAB	Toggles between multiple result screens.
TEST	Starts / stops the measurement.
MEM	Stores measured results / recalls stored results.

Vector angles are obtained from Fourier transform, which is performed on 10-cycle, 512 samples long samples stream. For detailed explanation about angles calculus see chapter 5.1.1.

5.1.4 THD

THD screen shows THD (total harmonic distortion) of voltages, currents which are measured by the instrument. Instrument shows relevant measurements according to the connection type: two-phase or three phase (Aaron) system.

THD measurement procedure

- ❑ Select appropriate connection type (see chapter: 4.2.1 Connection type).
- ❑ Configure clamp settings if needed (see chapter: 4.2.2 Clamp Settings).
- ❑ Select the **THD** sub-function using function selector and UP/DOWN keys.

- ❑ Measurements will start automatically.
- ❑ **Connect** test lead and current clamps to the instrument.
- ❑ **Connect** test lead to the item to be measured (see Figure 4.3 and Figure 4.4).
- ❑ **Embrace** wires where current should be measured.
- ❑ Press the **TEST** key to stop the measurement. All sub-functions will stop.
- ❑ **Store** the result by pressing the **MEM** key (optional).
- ❑ Press the **TEST** key again to start the measurement. All sub-functions will start.

THD	L1		L2	
thdU	8.2	%	22.0	%
thdU	8.2	V	33.1	V
thdI	6.0	%	24.6	%
thdI	5.39	A	17.2	A

Figure 5.8: THD measurement in 2-phase system

Displayed results for 2-phase system:

- thdU₁(%).. Total harmonic distortion of U₁ expressed in percent of first harmonic
- thdU₁(V) .. Total harmonic distortion of U₁ expressed in volts
- thdU₂(%).. Total harmonic distortion of U₂ expressed in percent of first harmonic
- thdU₂(V) .. Total harmonic distortion of U₂ expressed in volts
- thdI₁(%) ... Total harmonic distortion of I₁ expressed in percent of first harmonic
- thdI₁(A) Total harmonic distortion of I₁ expressed in volts
- thdI₂(%) ... Total harmonic distortion of I₁ expressed in percent of first harmonic
- thdI₂(A) Total harmonic distortion of I₁ expressed in volts

THD	L12		L23	
thdU	8.2	%	22.0	%
thdU	8.2	V	33.1	V
thdI	6.0	%	24.6	%
thdI	5.39	A	17.2	A

THD	L23		L31	
thdU	8.2	%	22.0	%
thdU	8.2	V	33.1	V
thdI	6.0	%	24.6	%
thdI	5.39	A	17.2	A

Figure 5.9: THD measurement in 3-phase (Aaron) system

Displayed results for three-phase (Aaron) system:

- thdU₁₂(%) Total harmonic distortion of U₁₂ expressed in percent of first harmonic
- thdU₁₂(V) . Total harmonic distortion of U₁₁ expressed in volts
- thdU₂₃(%) Total harmonic distortion of U₂₃ expressed in percent of first harmonic
- thdU₂₃(V) . Total harmonic distortion of U₂₃ expressed in volts
- thdU₃₁(%) Total harmonic distortion of U₃₁ expressed in percent of first harmonic
- thdU₃₁(V) . Total harmonic distortion of U₃₁ expressed in volts
- thdI₁₂(%).. Total harmonic distortion of current I₁ on L1 in percent of first harmonic
- thdI₁₂(A)... Total harmonic distortion of current I₁ on L2 in amperes.
- thdI₂₃(%).. Total harmonic distortion of current I₂ on L2 in percent of first harmonic
- thdI₂₃(A)... Total harmonic distortion of current I₂ on L2 in amperes.
- thdI₃₁(%).. Total harmonic distortion of current I₃ on L3 in percent of first harmonic
- thdI₃₁(A)... Total harmonic distortion of current I₃ on L3 in amperes.

Keys:

Function selector

Toggles between the main functions.

UP/DOWN	Toggles between sub-functions.
TAB	Toggles between multiple result screens.
TEST	Starts / stops the measurement.
MEM	Stores measured results / recalls stored results.

Total harmonic distortion is calculated according to the following calculus:

$$\text{Total voltage harmonic distortion (\%): } THD_{U_p} = \sqrt{\sum_{n=2}^{25} \left(\frac{U_p h_n}{U_p h_1} \right)^2}, \quad p: 1,2,3 \quad (20)$$

$$\text{Total voltage harmonic distortion (V): } THD_{U_p} = \sqrt{\sum_{n=2}^{25} (U_p h_n)^2}, \quad p: 1,2,3$$

$$\text{Total current harmonic distortion(\%): } THD_{I_p} = \sqrt{\sum_{n=2}^{25} \left(\frac{I_p h_n}{I_p h_1} \right)^2}, \quad p: 1,2,3 \quad (21)$$

$$\text{Total current harmonic distortion(A): } THD_{I_p} = \sqrt{\sum_{n=2}^{25} (I_p h_n)^2}, \quad p: 1,2,3 \quad (22)$$

5.2 Resistance of connections

The resistance measurement is performed in order to ensure good bonding and joints. Two sub-functions are available:

- R LOWΩ - Earth bond resistance measurement according to EN 61557-4 (200 mA)
- CONTINUITY - Continuous resistance measurement performed with 7 mA

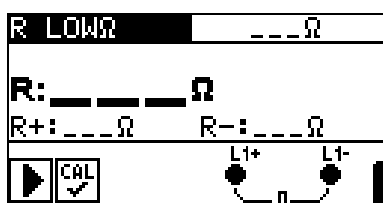

Figure 5.10: 200 mA RLOW Ω screen

Test parameters for resistance measurement

TEST	Resistance measurement sub-function [R LOWΩ, CONTINUITY]
Limit	Maximum resistance [OFF, 0.1 Ω ÷ 20.0 Ω]

Keys in test parameter field:

TAB	Selects the test parameter to be set or modified.
UP/DOWN	Selects test parameter value.

5.2.1 R LOW Ω , 200 mA resistance measurement

The resistance measurement is performed with automatic polarity reversal of the test voltage.

Test circuit for R LOW Ω measurement

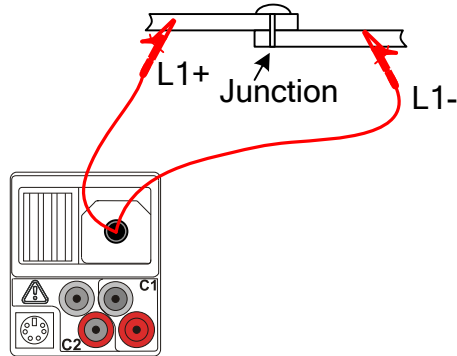

Figure 5.11: Junction resistance measurement example

Resistance measurement procedure

- ❑ Select **R LOW Ω** sub-function using the function selector and UP/DOWN keys.
- ❑ Enable and set **limit** (optional).
- ❑ **Connect** test lead to the instrument.
- ❑ **Compensate** the test leads resistance (if necessary, see *chapter 5.2.3*).
- ❑ **Disconnect** from mains supply and discharge the object to be tested.
- ❑ **Connect** the test leads L1+ and L1- to the tested object (see *Figure 5.11*).
- ❑ Press the **TEST** key to perform the measurement.
- ❑ After the measurement is finished **store** the result by pressing the **MEM** button (optional).

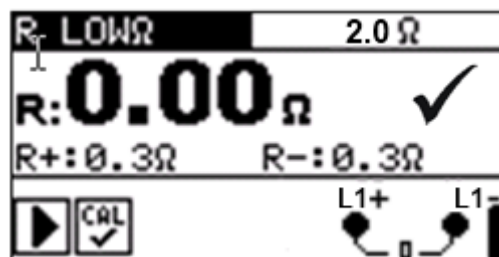

Figure 5.12: Example of RLOW result

Displayed results:

- R.....R LOW Ω resistance.
- R+.....Result at positive test polarity
- R-.....Result at negative test polarity

Keys:

Function selector	Toggles between the main functions.
UP/DOWN	Toggles between sub-functions.
	Selects the test parameter value.
TAB	Selects the test parameter field.
TEST	Starts the measurement.
MEM	Stores measured results / recalls stored results.

5.2.2 Continuous resistance measurement with low current

In general, this function serves as standard Ω -meter with a low testing current. The measurement is performed continuously without polarity reversal. The function can also be applied for testing continuity of inductive components.

Test circuit for continuous resistance measurement

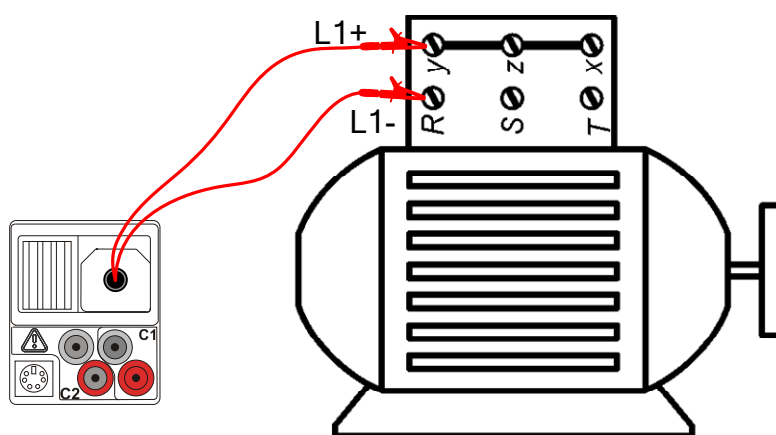

Figure 5.13: 2-wire test lead application

Continuous resistance measurement procedure

- ❑ Select **CONTINUITY** sub-function using the function selector and UP/DOWN keys.
- ❑ Enable and set **limit** (optional).
- ❑ **Connect** test lead to the instrument.
- ❑ **Compensate the** test leads resistance (if necessary, see *chapter 5.2.3*).
- ❑ **Disconnect** from mains supply and discharge the object to be tested.
- ❑ **Connect** the test leads L1+ and L1- to the tested object (see *Figure 5.13*).
- ❑ Press the **TEST** key to begin performing a continuous measurement.
- ❑ Press the **TEST** key to stop measurement.
- ❑ **Store** the result (optional).

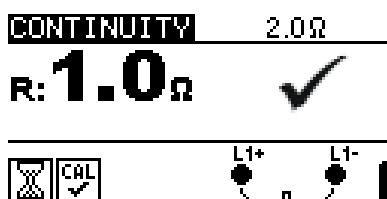

Figure 5.14: Example of continuous resistance measurement

Displayed result:

R.....Resistance

Keys:

Function selector	Toggles between the main functions.
UP/DOWN	Toggles between sub-functions.
	Selects the test parameter value.
TAB	Selects the test parameter field.
TEST	Starts / stops the measurement.
MEM	Stores measured results / recalls stored results.

Note:

- Continuous buzzer sound indicates that measured resistance is less than 2 Ω .

5.2.3 Compensation of test leads resistance

This chapter describes how to compensate the test leads resistance in R LOW Ω and CONTINUITY sub-functions. Compensation is required to eliminate the influence of test leads resistance and the internal resistances of the instrument on the measured resistance. The lead compensation is therefore a very important feature to obtain correct result.



symbol is displayed if the compensation was carried out successfully.

Circuit for compensating the resistance of test leads

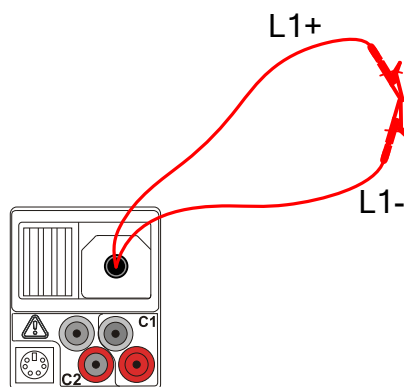



Figure 5.15: Shorted test leads

Compensation of test leads resistance procedure

- Select **R LOW Ω** or **CONTINUITY** function.
- **Connect** test cable to the instrument and short the L1+ and L1- test leads together (see Figure 5.15).
- Press the **HELP/CAL** key to compensate leads resistance.
- Press **TEST** to verify compensation.

Displayed results:

Test leads compensated

Test leads not compensated

Key:

HELP/CAL	Starts compensation of test leads resistance procedure.
-----------------	---

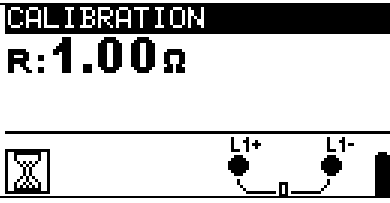
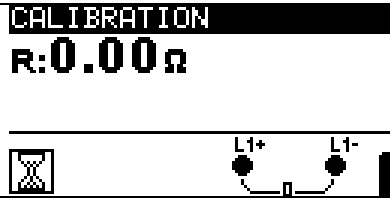
	
<p><i>Figure 5.16: Result with old calibration value</i></p>	<p><i>Figure 5.17: Result with new calibration value</i></p>

Note:

- The highest value for lead compensation is 5 Ω. If the resistance is higher the compensation value is set back to default value.

 is displayed if no calibration value is stored.

6 Data handling

6.1 Memory organization

Measurement results together with all relevant parameters can be stored in the instrument’s memory. After the measurement is completed, results can be stored to the flash memory of the instrument, together with the sub-results and function parameters.

6.2 Data structure

The instrument’s memory place is divided into 3 levels each containing 199 locations. The number of measurements that can be stored into one location is not limited.

The **data structure field** describes the location of the measurement (which object, block, fuse) and where can be accessed.

In the **measurement field** there is information about type and number of measurements that belong to the selected structure element (object and block and fuse).

The main advantages of this system are:

- Test results can be organized and grouped in a structured manner that reflects the structure of typical electrical installations.
- Customized names of data structure elements can be uploaded from EurolinkPRO PCSW.
- Simple browsing through structure and results.
- Test reports can be created with no or little modifications after downloading results to a PC.

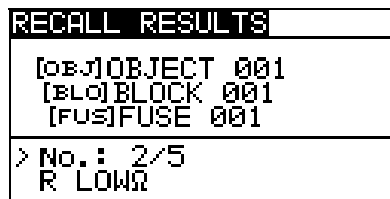

Figure 6.1: Data structure and measurement fields

Data structure field	Memory operation menu
RECALL RESULTS	Memory operation menu
OBJECT: 001 BLOCK: 001 FUSE: 001	Data structure field
OBJECT: 001	<ul style="list-style-type: none"> □ 1st level: OBJECT: Default location name (object and its successive number).
BLOCK: 001	<ul style="list-style-type: none"> □ 2nd level: BLOCK: Default location name (block and its successive number).
FUSE: 001	<ul style="list-style-type: none"> □ 3rd level: FUSE: Default location name (fuse and its successive number). □ 001: No. of selected element.
No. : 20 [112]	No. of measurements in selected location [No. of measurements in selected location and its sub-locations]

Measurement field

R LOWR

Type of stored measurement in the selected location.

No.: 2/5

No. of selected test result / No. of all stored test results in selected location.

6.3 Storing test results

After the completion of a test the results and parameters are ready for storing (📁 icon is displayed in the information field). By pressing the **MEM** key, the user can store the results.

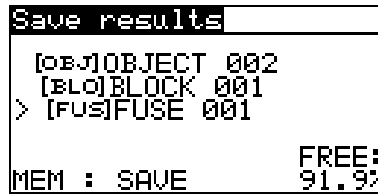

Figure 6.2: Save test menu

Memory free: 99.6% Memory available for storing results.

Keys in save test menu:

TAB	Selects the location element (Object / Block / Fuse)
UP / DOWN	Selects number of selected location element (1 to 199)
MEM / TEST	Saves test results to the selected location.
Function selector / ESC	Exits back without saving.

Notes:

- The instrument offers to store the result to the last selected location by default.
- If the measurement is to be stored to the same location as the previous one just press the **MEM** key twice.

6.4 Recalling test results

Press the **MEM** key in measurement sub-functions when there is no result available for storing or select **MEMORY** in the **SETTINGS** menu.

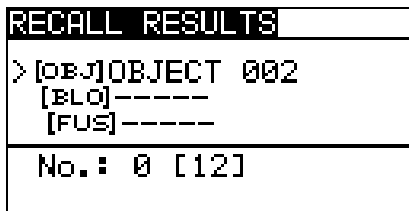

Figure 6.3: Recall menu - structure field selected

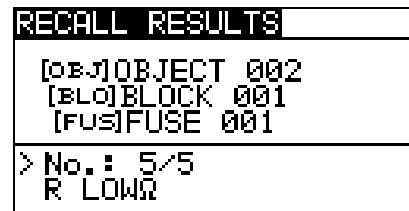

Figure 6.4: Recall menu - measurements field selected

Keys in recall memory menu (structure field selected):

TAB	Selects the location element (Object / Block / Fuse).
UP / DOWN	Selects number of selected location element (1 to 199).
TEST / MEM	Enters measurements field.
Function selector / ESC	Exits back.

Keys in recall memory menu (measurements field selected):

UP / DOWN	Selects the stored measurement.
TEST / MEM	View selected measurement results.
TAB / ESC	Returns to installation structure field.
Function selector	Exits back.



Figure 6.5: Example of recalled measurement result

Keys in recall memory menu (measurement results are displayed):

HELP	Toogles between multiple result screens.
TEST / MEM	Returns to measurements field.
Function selector / ESC	Exits back.

6.5 Clearing stored data

6.5.1 Clearing complete memory content

Select **CLEAR ALL MEMORY** in **MEMORY** menu. A warning will be displayed.

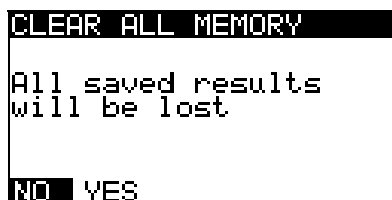

Figure 6.6: Clear all memory menu

Keys in clear all memory menu:

UP / DOWN	Selects YES or NO.
TEST	Confirms clearing memory (if YES is selected)
	Exits back without changes (if NO is selected).
Function selector / ESC	Exits back without changes.

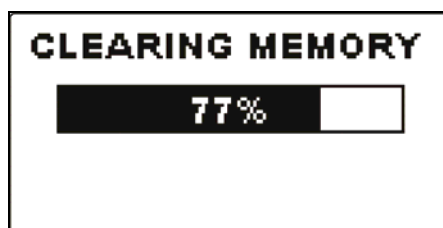

Figure 6.7: Clearing memory in progress

6.5.2 Clearing measurement(s) in selected location

Select **DELETE RESULTS** in **MEMORY** menu.

DELETE RESULTS	DELETE RESULTS
[OBJ]OBJECT 002 > [BLK]BLOCK 001 [FUS]-----	[OBJ]OBJECT 002 [BLK]BLOCK 001 > [FUS]FUSE 001
No.: 1 [6]	No.: 5

Figure 6.8: Clear measurements menu (data structure field selected)

Keys in delete results menu (structure field selected):

TAB	Selects the location element (Object / Block / Fuse).
UP / DOWN	Selects number of selected location element (1 to 199).
TEST	Enters dialog box for deleting all measurements in selected location and its sub-locations.
Function selector / ESC	Exits back without changes.
MEM	Enters measurements field for deleting individual measurements.

Keys in dialog for confirmation to clear results in selected location:

TEST	Deletes all results in selected location.
Function selector / ESC	Exits back without changes.

6.5.3 Clearing individual measurements

Select **DELETE RESULTS** in **MEMORY** menu.

DELETE RESULTS
[OBJ]OBJECT 002 [BLK]BLOCK 001 [FUS]FUSE 001
> No.: 5/5 R LOWΩ

Figure 6.9: Menu for clearing individual measurement (structure field selected)

Keys in delete results menu (structure field selected):

TAB	Selects the location element (Object / Block / Fuse).
UP / DOWN	Selects number of selected location element (1 to 199).
MEM	Enters measurements field for deleting individual measurements.
Function selector / ESC	Exits back without changes.

Keys in delete results menu (measurements field selected):

UP / DOWN	Selects measurement.
TEST	Enters dialog box for deleting individual measurement.
TAB / ESC	Returns to structure field.
Function selector	Exits back without changes.

Keys in dialog for confirmation to clear selected result(s):

TEST	Deletes selected measurement result.
Function selector / ESC	Exits back without changes.

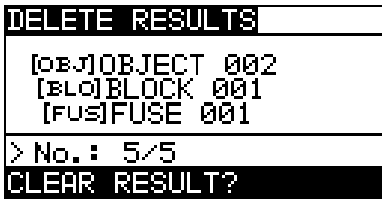

Figure 6.10: Dialog for confirmation

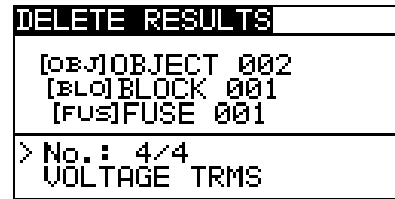

Figure 6.11: Display after measurement was cleared

6.5.4 Renaming installation structure elements

Default structure elements are 'Object', 'Block' and 'Fuse'. In the PCSW package Eurolink-PRO default names can be changed with customized names that corresponds the measured object. Refer to PCSW Eurolink-PRO HELP menu for information how to upload customized names structure to the instrument.

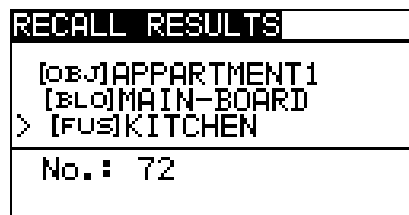

Figure 6.12: Example of menu with customized installation structure names

6.6 Communication

Stored results can be transferred to a PC. A special communication program on the PC automatically identifies the instrument and enables data transfer between the instrument and the PC.

There are two communication interfaces available on the instrument: USB or RS 232.

The instrument automatically selects the communication mode according to detected interface. USB interface has priority.

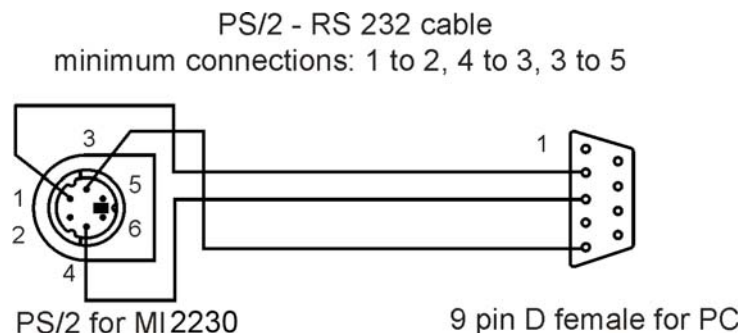

Figure 6.13: Interface connection for data transfer over PC COM port

How to transfer stored data:

- RS 232 communication: connect a PC COM port to the instrument PS/2 connector using the PS/2 - RS232 serial communication cable;
- USB communication: connect a PC USB port to the instrument USB connector using the USB interface cable.
- Switch **on** the PC and the instrument.
- **Run** the *EuroLinkPRO* program.
- The PC and the instrument will automatically recognize each other.
- The instrument is prepared to download data to the PC.

The program *EuroLinkPRO* is a PC software running on Windows XP, Windows Vista and Windows 7. Read the file README_EuroLink.txt on CD for instructions about installing and running the program.

Note:

- USB drivers should be installed on PC before using the USB interface. Refer to USB installation instructions available on installation CD.

7 Maintenance

Unauthorized persons are not allowed to open the VAFMeter instrument. There are no user replaceable components inside the instrument, except the battery and fuse under rear cover.

7.1 Fuse replacement

There is a fuse under back cover of the instrument.

- F1
M 0.315 A / 250 V, 20×5 mm
This fuse protects internal circuitry for continuity functions if test probes are connected to the mains supply voltage by mistake during measurement.
- F2
F 4 A / 500 V, 32×6 mm
This fuse protects internal circuitry for continuity functions if test probes are connected to the mains supply voltage by mistake during measurement.
- F3
F 4 A / 500 V, 32×6 mm
This fuse protects internal circuitry for continuity functions if test probes are connected to the mains supply voltage by mistake during measurement.

Warnings:

-  **Disconnect all measuring accessory and switch off the instrument before opening battery / fuse compartment cover, hazardous voltage inside!**
- **Replace blown fuse with original type only, otherwise the instrument may be damaged and/or operator's safety impaired!**

Position of fuse can be seen in Figure 3.6 in chapter 3.3 Back side

7.2 Cleaning

No special maintenance is required for the housing. To clean the surface of the instrument use a soft cloth slightly moistened with soapy water or alcohol. Then leave the instrument to dry totally before use.

Warnings:

- Do not use liquids based on petrol or hydrocarbons!
- Do not spill cleaning liquid over the instrument!

7.3 Periodic calibration

It is essential that the test instrument is regularly calibrated in order that the technical specification listed in this manual is guaranteed. We recommend an annual calibration. Only an authorized technical person can do the calibration. Please contact your dealer for further information.

7.4 Service

For repairs under warranty, or at any other time, please contact your distributor.

7.5 Upgrading the instrument

The instrument can be upgraded from a PC via the RS 232 communication port. This enables to keep the instrument up to date even if the standards or regulations change. The upgrade can be carried with a help of special upgrading software and the communication cable as shown on *Figure 6.13*. Please contact your dealer for more information.

8 Technical specifications

8.1 General data

Power supply voltage.....	9 V _{DC} (6×1.5 V battery or accu, size AA)
Operation.....	typical 20 h
Charger socket input voltage	12 V ± 10 %
Charger socket input current	400 mA max.
Battery charging current	250 mA (internally regulated)
Overvoltage category.....	600 V CAT II
Protection classification	double insulation
Pollution degree.....	2
Protection degree	IP 40
Display	128x64 dots matrix display with backlight
Dimensions (w × h × d).....	23 cm × 10,3 cm × 11,5 cm
Weight	1.0 kg, without battery cells

Reference conditions

Reference temperature range.....	10 °C ÷ 30 °C
Reference humidity range.....	40 %RH ÷ 70 %RH

Operation conditions

Working temperature range	-10 °C ÷ 50 °C
Maximum relative humidity	95 %RH (0 °C ÷ 40 °C), non-condensing

Storage conditions

Temperature range	-10 °C ÷ +70 °C
Maximum relative humidity	90 %RH (-10 °C ÷ +40 °C) 80 %RH (40 °C ÷ 60 °C)

The error in operating conditions could be at most the error for reference conditions (specified in the manual for each function) +1 % of measured value + 1 digit, unless otherwise specified in the manual for particular function.

8.2 Voltage

Measuring range (V)	Resolution (V)	Accuracy	Crest factor
10.0 ÷ 600.0	0.1	±(0,5 % of reading + 3 digits)	1.4

Result type.....	True r.m.s. (trms)
Input impedance	8.8 MΩ
Nominal frequency range.....	DC, 45 Hz ÷ 65 Hz

8.3 Frequency*

Measuring range (Hz)	Resolution (Hz)	Accuracy
45.00 ÷ 65.00	0.01	±20 mHz

*Frequency is measured on voltage channel L1, if present. Otherwise frequency of current channel I1 is measured.

8.4 Current (A 1398 - 10A current clamps)

Measuring range (A)	Resolution (mA)	Accuracy
50.0 m ÷ 99 m	1	±(1,5 % of reading + 5 digits)
100 m ÷ 999 m	1	±(1,5 % of reading + 2 digits)
1.000 ÷ 9.999	1	±(1,5 % of reading + 2 digits)
10.00 ÷ 19.99	10	±(1,5 % of reading + 2 digits)

Result type..... True r.m.s. (trms)

Input resistance 10 Ω

8.5 Current (A 1395 – flex clamps)

Clamp Range	Measuring range (A)	Resolution (A)	Accuracy
30 A	3.0 ÷ 29.9 A	0.1 A	±(3 % of reading + 2 digits)
300 A	30.0 ÷ 299.9 A	0.1 A	±(3 % of reading + 2 digits)
3000 A	300.0 A ÷ 999.9 A 1000 A ÷ 6000 A	0.1 1 A	±(3 % of reading + 2 digits)

Result type..... True r.m.s. (trms)

Input resistance 27 kΩ

8.6 Power (W, VA, Var)

		Measuring range (W, VAr, VA)	Resolution	Accuracy
Active power P	Excluding clamps	0.000 k ÷ 9999 k	4 digits	±(1.5 % of rdg. + 4 digits)
	With A 1398 Clamps 10A	0.000 k ÷ 9999 k		±(2 % of rdg. + 4 digits)
	With A 1395 30/300/3000 A	0.000 k ÷ 9999 k		±(3.5 % of rdg. + 4 digits)
Reactive power Q	Excluding clamps	0.000 k ÷ 9999 k	4 digits	±(1.5 % of rdg. + 4 digits)
	With A 1398 Clamps 10A	0.000 k ÷ 9999 k		±(2 % of rdg. + 4 digits)
	With A 1395 30/300/3000 A	0.000 k ÷ 9999 k		±(3.5 % of rdg. + 4 digits)
Apparent power S	Excluding clamps	0.000 k ÷ 9999 k	4 digits	±(1.5 % of rdg. + 4 digits)
	With A 1398 Clamps 10A	0.000 k ÷ 9999 k		±(2 % of rdg. + 4 digits)
	With A 1395 30/300/3000 A	0.000 k ÷ 9999 k		±(3.5 % of rdg. + 4 digits)

8.7 Power factor - PF

Measuring range	Resolution	Accuracy
-1.00 ÷ 1.00	0.01	± 0.04

8.8 Cos φ - DPF

Measuring range	Resolution	Accuracy
0.00 ÷ 1.00	0.01	± 0.04

8.9 Phase angle

Measuring range (°)	Resolution (°)	Accuracy (°)
-180.0 ÷ +180.0	0.1	± 0.5

8.10 Voltage and current THD

Measuring range	Resolution (%)	Accuracy
0 % $U_{\text{Range}} < \text{THD}_U < 20 \% U_{\text{Range}}$	0.1	± 0.5

U_{Range} : Voltage range (V)

Measuring range	Resolution (%)	Accuracy
0 % $I_{\text{Range}} < \text{THD}_I < 100 \% I_{\text{Range}}$	0.1	± 0.6

I_{Range} : Current range (A)

8.11 Resistance / Continuity

8.11.1 Resistance R LOWΩ

Measuring range according to EN61557 is 0.16 Ω ÷ 1999 Ω.

Measuring range R (Ω)	Resolution (Ω)	Accuracy
0.00 ÷ 19.99	0.01	±(3 % of reading + 3 digits)
20.0 ÷ 199.9	0.1	±(5 % of reading)
200 ÷ 1999	1	

Open-circuit voltage6.5 VDC ÷ 9 VDC

Measuring current.....min. 200 mA into load resistance of 2 Ω

Test lead compensation.....up to 5 Ω

The number of possible tests> 2000, with a fully charged battery

Automatic polarity reversal of the test voltage.

8.11.2 Resistance CONTINUITY

Measuring range (Ω)	Resolution (Ω)	Accuracy
0.0 ÷ 19.9	0.1	±(5 % of reading + 3 digits)
20 ÷ 1999	1	

Open-circuit voltage6.5 VDC ÷ 9 VDC

Short-circuit currentmax. 8.5 mA

Test lead compensation.....up to 5 Ω